

ELBOW CxF NO.14 20mm OD x 15mm FI

Product Code : 83120

Brand Name: **elson**

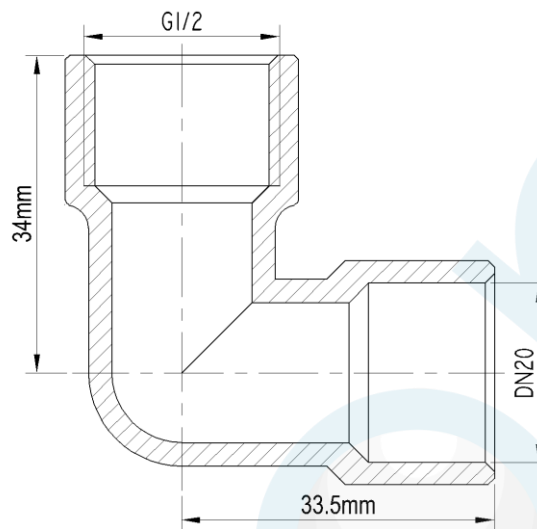

Product Specification

- Watermark Licence Number: WMKA 02497
- In compliance with AS 3688
- Material: DR Brass, Complies with AS 2345
- Suitable for Potable Water – complies with AS/NZS 4020
- Maximum Working Temperature: 95°C
- Maximum Working Pressure at 20°C : 2100Kpa
- Threads are all BSP

Elson Australasia Pty Ltd

Tel: 02 9625 7899 Fax: 02 9625 7855

Website: www.elson.net.au E-mail: sales@elson.net.au

Version 2.0

Aug. 2020